

# APPLICATION OF THE SA-RT METHOD TO SUPERVISORY SYSTEMS

M.N. LAKHOVA

Member IEEE

Laboratory of Analysis and Command of Systems (LACS)

ENIT, BP 37, Le Belvedere, 1002 Tunis, Tunisia

E-mail: MohamedNajeh.Lakhova@ieee.org

**Abstract:** After a presentation of the functionality of the supervisory control and data acquisition system (SCADA), we present the issues involved in the application of a Functional Analysis (FA) technique on a supervisory system of a complex process. In order to deal with these issues, we present a practical case of a SCADA system of a thermal power plant (TPP) in Tunisia. Our contribution consists on applying a FA technique SA-RT (Structured Analysis Real Time). This technique allows a functional description of the SCADA system. The paper briefly discusses the functions of the SCADA system and some advantages of the application of the FA for the design of a supervisory system. Then the basic principles of the SA-RT technique applied on the SCADA system are presented. Finally, the different results obtained from the SA-RT technique are discussed.

**Key words:** Supervisory system; SCADA system, functional analysis, SA-RT method.

## 1. Introduction

Today, the supervision of production systems is more and more complex to perform, not only because of the number of variables always more numerous to monitor but also because of the numerous interrelations existing between them, very difficult to interpret when the process is highly automated.

The challenge of the future years is based on the design of support systems which let an active part to the supervisory operators by supplying tools and information allowing them to understand the running of production equipment. Indeed, the traditional supervisory systems present many already known problems. First, whereas sometimes the operator is saturated by an information overload, some other times the information under load does not permit them to update their mental model of the supervised process.

Moreover, the supervisory operator has a tendency to wait for the alarm to act, instead of trying to foresee or anticipate abnormal states of the system. So, to avoid these perverse effects and to make operator's work more active, the design of future supervisory systems has to be human centered in order to optimize Man-Machine interactions.

It seems in fact important to supply the means to this operator to perform his own evaluation of

the process state. To reach this objective, Functional Analysis seems to be a promising research method. In fact, allowing the running of the production equipment to be understood, these techniques permit designers to determine the good information to display through the supervisory interfaces dedicated to each kind of supervisory task (monitoring, diagnosis, action, etc.). In addition, Functional Analysis techniques could be a good help to design support systems such as alarm filtering systems.

By means of a significant example, the objective of this paper is to show interests of the use of Functional Analysis (FA) techniques such as SA-RT (Structured Analysis Real Time) for the design of supervisory systems. An example of a SCADA system of a thermal power plant (TPP) in Tunisia is presented. The next section briefly describes the characteristics of the SCADA system and the problems linked to its design. Next, the interests of using SA-RT in the design steps are developed. In Section 3, after presenting concepts of SA-RT, this technique is applied to the SCADA system of the TPP. The last section presents a discussion about the advantages and inconveniences of FA techniques.

## 2. Functionality of a SCADA system

Supervision consists of commanding a process and supervising its working. To achieve this goal, the supervisory system of a process must collect, supervise and record important sources of data linked to the process, to detect the possible loss of functions and alert the human operator [1].

The main objective of a supervisory system is to give the means to the human operator to control and to command a highly automated process. So, the supervision of industrial processes includes a set of tasks aimed at controlling a process and supervising its operation.

A supervised system is composed of the following parts:

- The Man-Machine Interfaces (MMI), displaying information thanks to the information synthesis system.
- The supervisory tools, supplying services thanks to the automatic supervisory system and the decision support systems.
- The control/command part, interface between the MMI, the supervisory tools and the process.
- The process is also called production system or operative part, performing the physical work on the input product flow.

A supervisory system has to give to the human operator [2]:

- A global view of the installation and its operation. The operator must access this pertinent information, without much reasoning.
- Information concerning the evolution of the process state.
- Information which permits results of operator's actions to be controlled quickly.
- The means to drive away into the different levels of process abstraction.
- Good alarms; i.e. well defined, well commented and specific to the different running modes.

An automatic supervisory system is a traditional supervisory system, that is to say, a system which provides a hierarchical list of alarms generated by a simple comparison with regard to thresholds. The information synthesis system manages the presentation of information via any support (synoptic, console, panel, etc.) to the human operator.

SCADA is the acronym for "supervisory control and data acquisition." SCADA systems are widely used in industry for supervisory control and data acquisition of industrial processes. The process can be industrial, infrastructure or facility [3][4] [5] [6].

In fact, most control actions are performed automatically by RTU or by programmable logic controllers (PLC) [7] [8]. Host control functions are usually restricted to basic overriding or supervisory level intervention. For example, a PLC may control the flow of cooling water through part of an industrial process, but the SCADA system may allow operators to change the set points for the flow, and enable alarm conditions, such as loss of flow and high temperature, to be displayed and recorded [9] [10]. The feedback control loop passes through the RTU or PLC, while the SCADA system monitors the overall performance of the loop.

We present in this part some applications of

SCADA systems that have been presented in various researches.

Researcher, Poon H.L. [11], has tried to make a survey of the current development of data acquisition technology. The various practical considerations in applying Data Acquisition Systems are summarized, and some feasible areas of advanced applications are investigated.

Researchers, Ozdemir E. & al. [12], have used a Java-enabled mobile as a client in a sample SCADA application in order to display and supervise the position of a sample prototype crane. The wireless communication between the mobile phone and the SCADA server is performed by means of a base station via general packet radio service GPRS and wireless application protocol WAP. Test results have indicated that the mobile phone based SCADA integration using the GPRS or WAP transfer scheme could enhance the performance of the crane in a day without causing an increase in the response times of SCADA functions.

Researcher, Horng J.H. [13], has presented a SCADA of DC motor with implementation of fuzzy logic controller (FLC) on neural network (NN). He has successfully avoided complex data processing of fuzzy logic in the proposed scheme. After designed a FLC for controlling the motor speed, a NN is trained to learn the input-output relationship of FLC. The tasks of sampling and acquiring the input signals, process of the input data, and output of the voltage are commanded by using LabVIEW. Finally, the experimental results are provided to confirm the performance and effectiveness of the proposed control approach.

Researcher, Aydogmus Z. [14], has presented a SCADA control via PLC for a fluid level control system with fuzzy controller. For this purpose, a liquid level control set and PLC have been assembled together. The required fuzzy program algorithms are written by the author. Sugeno type fuzzy algorithm has been used in this study. A SCADA system has been composed for monitoring of water level in tank and position of the actuator valve. The main objective of this work is to present an implementation setup has been realized with no fuzzy logic controller module/software in this study.

Researcher, Munro K. [15], has developed the idea that SCADA systems are being rapidly integrated with corporate networks but the ramifications of a SCADA breach are far more worrying than disruption to production.

Researchers, Patel M. & al. [16], have presented a SCADA system that allows communication with, and controlling the output

of, various I/O devices in the renewable energy systems and components test facility RESLab. This SCADA system differs from traditional SCADA systems in that it supports a continuously changing operating environment depending on the test to be performed. The SCADA System is based on the concept of having one Master I/O Server and multiple client computer systems.

Researchers, Ralston P.A.S., & al. [17], have provided a broad overview of cyber security and risk assessment for SCADA and DCS, have introduced the main industry organizations and government groups working in this area, and have given a comprehensive review of the literature to date. Presented in broad terms is probability risk analysis which includes methods such as FTA, ETA, and FMEA. The authors have concluded with a general discussion of two recent methods that quantitatively determine the probability of an attack, the impact of the attack, and the reduction in risk associated with a particular countermeasure.

Researchers, Avlonitis S.A. & al. [18], have presented the structure and the installation of a flexible and low cost SCADA system. An ordinary PC with the appropriate interface and software operates the system. The system was installed to an old desalination plant in parallel with the existing old type conventional automation system, which is using relays, timers, etc. The automation system allows remote control and supervision of the plant at reasonable low cost. The design and installation of the automation system, which includes the software and hardware, is simple and easily accessible.

The system has reduced the labor cost, and has increased the labor productivity of the operation due to the remote supervision of the process.

**3. Presentation of the SA-RT method**

Among the graphical methods most commonly used in industry, two of the leading methods are SA-RT and Statecharts. SA-RT is a short name for Structured Analysis Methods with extensions for Real Time [19] [20]. The model is represented as a hierarchical set of diagrams that includes data and control transformations (processes). Control transformations are specified using State Transition diagrams, and events are represented using Control Flows. The other graphical and state based paradigm for specification of real time systems is Statecharts. The system is represented as a set of hierarchical states instead of processes. Each state can be decomposed into sub states and so on. The statecharts notation is more compact than the SA-RT notation and has been formally defined.

Structured Analysis for Real-Time Systems, or SA-RT, is a graphical design notation focusing on analyzing the functional behavior of and information flow through a system [21] [22]. SA-RT, which in turn is a refinement of the structural analysis methods originally introduced by Douglass Ross and popularized by Tom DeMarco in the seventies, was first introduced by Ward and Mellor in 1985 and has thereafter been refined and modified by other researchers, one well-known example being the Hatley and Pirbhai proposal (Fig.1).

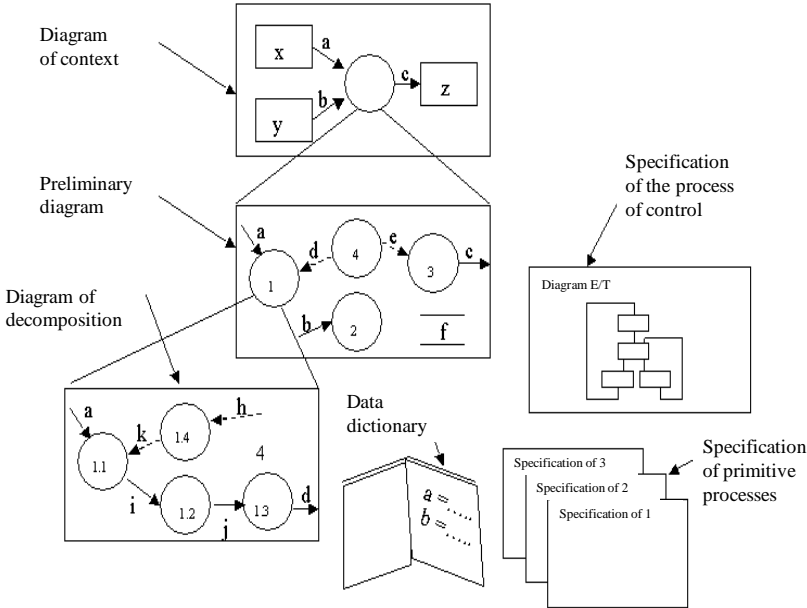

Fig. 1. Organization of an SA-RT model.

Thus, SA-RT is a complex method for system analysis and design. This is one of the most frequently used design method in technical and real-time oriented applications adopted by various Case-Tools. It is a graphical, hierarchical and implementation independent method for top-down development [20] [23].

SA-RT method enables us to identify an entrance and an exit of data in an algorithm or a computer program. It is divided in three modules: Diagram of Context, Data Flows

Diagram and Control Flows Diagram. Every module includes in its graphic interpretation different symbols [24] [25] [26] [27].

Indeed, the Diagram of Context in the SA-RT method is going to enable us to identify a process in a program in relation to the entered and exits of data (Fig.2). This process can have different units. This process will be able to be identified per seconds, in term of constant or variable but as this process will be able to be material type (Process interfacing).

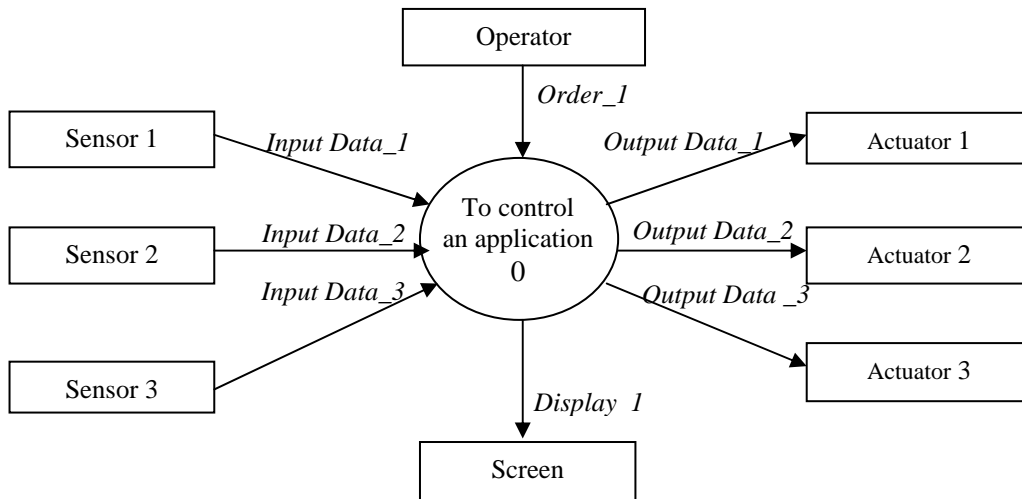

Fig. 2. Diagram of Context of the SA-RT method.

The different symbols used in a Diagram of Context of the SA-RT method are [20]:

- The termination is the element in end, final element that encloses the action. The termination is generally a direct tie between a terminator and the process.
- The flow of data is the final element that opens up on a last action.
- The flow of control is generally a tie back of the process toward the terminator. It can be a main element of the process.

The Data Flows Diagram is an under-process of the Diagram of Context. One can analyze every element of the Context Diagram and more especially terminators and flows of data. It is

going to concern entrances and exits of process exclusively (Fig.3).

The Control Flows Diagram is the last stage of the SA-RT analysis. The Control Flows Diagram represents in fact a summarized of the Context Diagram and the Data Flows Diagram while integrating the new exits and entrances (Fig.4).

The Process of control is going to either define a function, a procedure or a place with its internal or external parameters. It can happen that a process of control corresponds to a structure. It can be carrier of parameters in the setting of function or procedure but it is especially a tie between the process of control and an under-process.

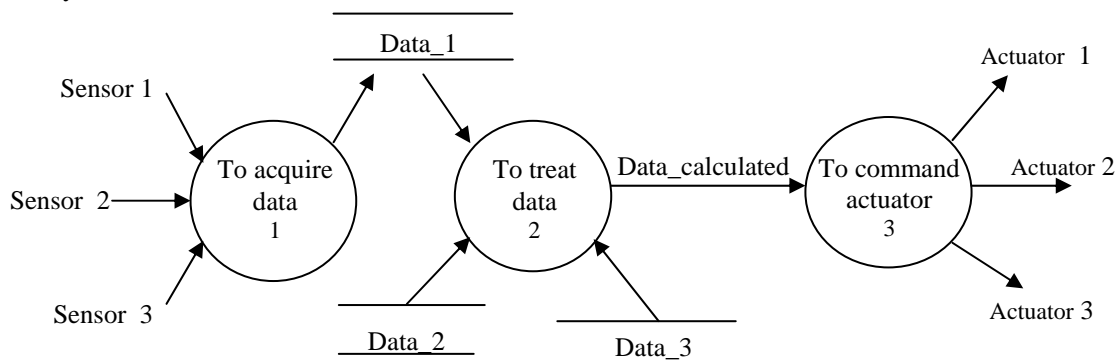

Fig. 3. Data Flows Diagram of the SA-RT method.

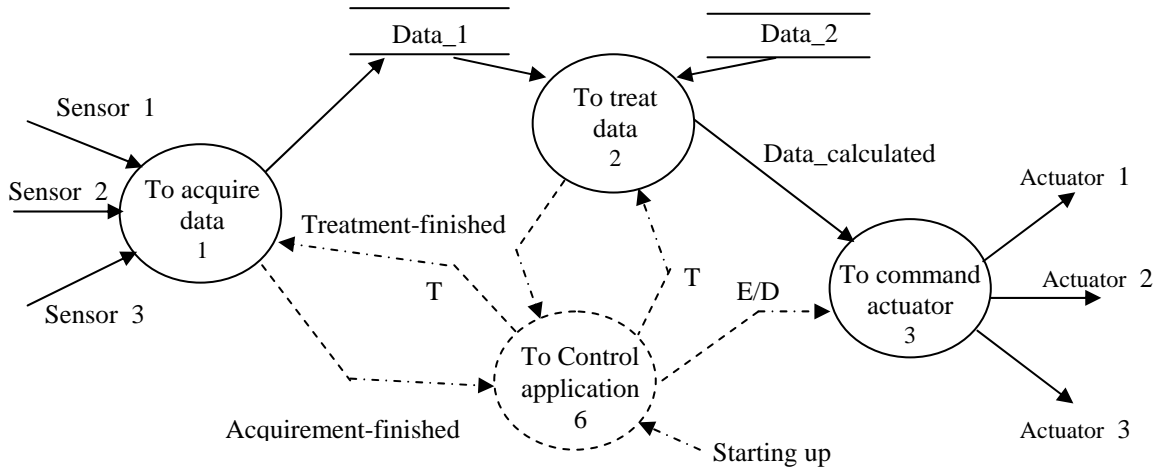

Fig. 4. Control Flows Diagram of the SA-RT method.

#### 4. Results of the SA-RT analysis

An example of a SCADA system of a thermal power plant (TPP) is presented. The stations belong to a superior network Ethernet (10 Mb/s). Principally, this network enables to exchange files between the stations. It enables to avoid the overload of the Node bus network.

In fact, the SCADA system is composed by modules that exchange information using the communication network (Fig.5). It exist three levels in the SCADA system: acquisition; treatment and Men/Machine Interface.

Based on the description of the SCADA system, a corresponding SA-RT model of the SCADA system of the TPP has been built. An important point must be noticed: the point of view of the analysis is that of a person without concrete experience on the SCADA system of a TPP, i.e. only through a bookish knowledge, whose objective is the use of the final models for

the design of supervisory displays (monitoring, diagnosis displays, etc.). In fact, the application of Functional Analysis (FA) technique must permit in this case:

- to determine the functions of the system;
- to put in evidence the different modes of running;
- to split up the system into sub-systems;
- to determine pertinent variables.

So, the SA-RT model is composed exclusively of diagrams. It starts with the main process 'To supervise the signals of the TPP' (Fig.6). Then, this process is broken into a preliminary data flows diagram composed of three processes (Fig.7). We continue the decomposition of the processes until the last decomposition level has been reached (levels DFD1, DFD2 and DFD3). An example of a decomposition level of the third process is presented (Fig.8) related the data flows diagram DFD3.

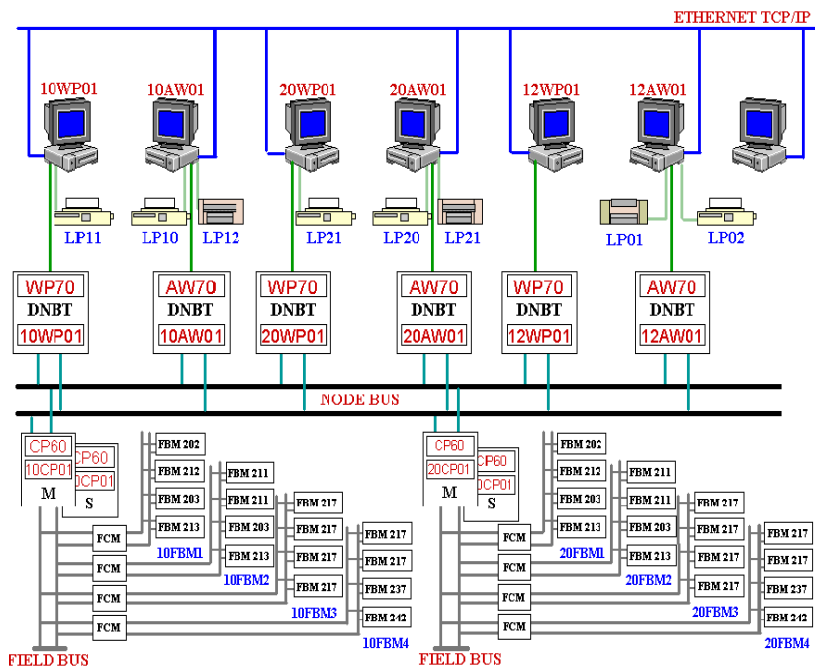

Fig. 5. Architecture of the SCADA system.

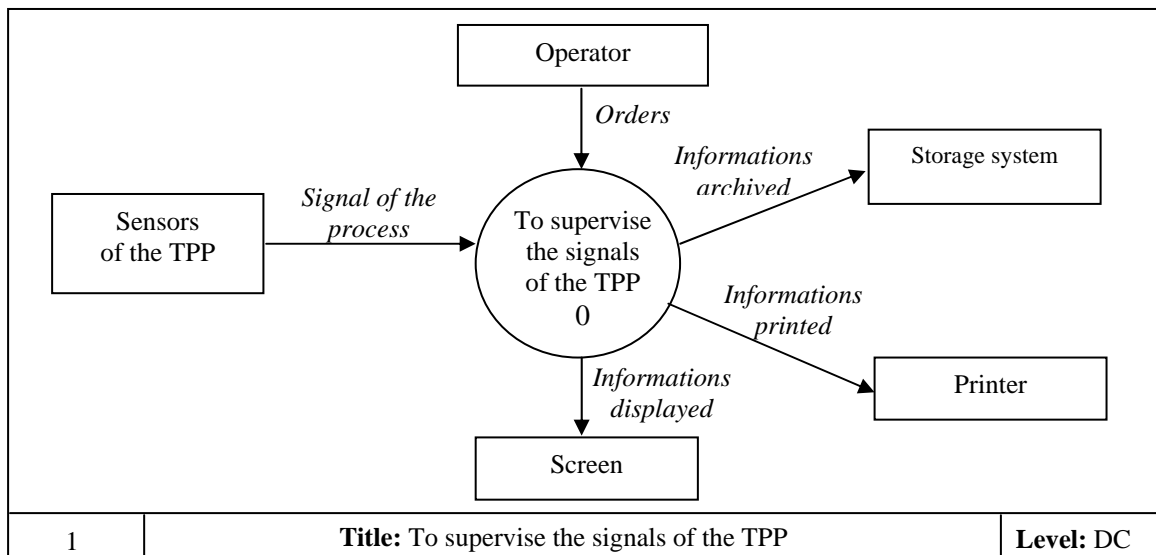

Fig. 6. Diagram of Context of the SCADA system.

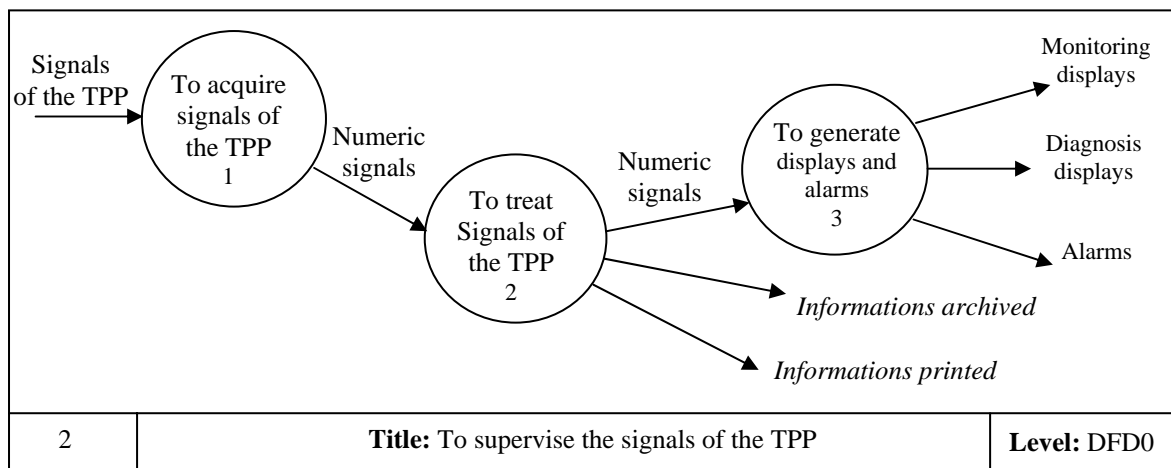

Fig. 7. Preliminary Data Flows Diagram of the SCADA system.

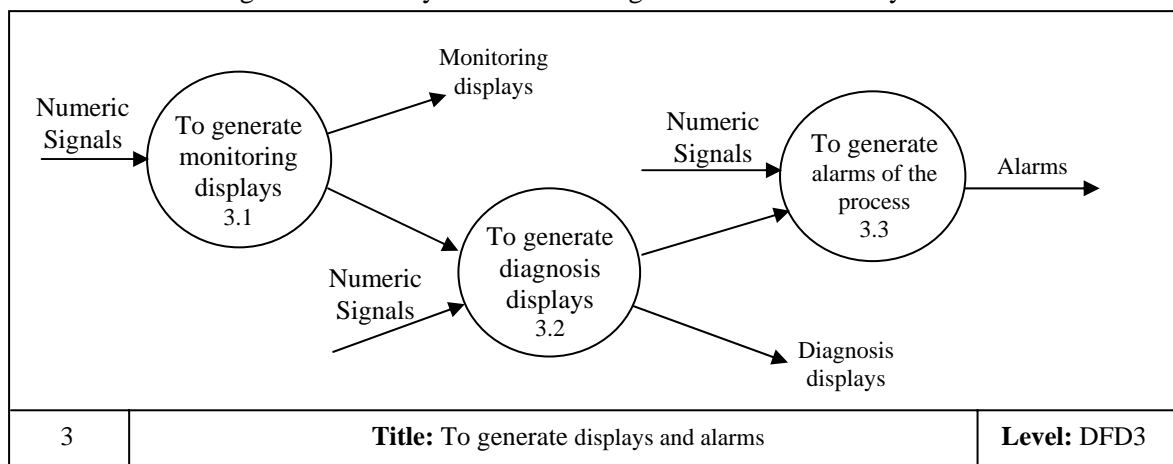

Fig. 8. Decomposition Data Flows Diagram (DFD3).

Recall that the techniques such as SA-RT are semi-formal. By consequence, for the same subject, different correct models can be built without having to know with certitude which model is the good or, at least, the best. In fact, this kind of model allows users sufficient freedom in its construction and so the subjective factor introduces a supplementary dimension for its validation. That is why the

validation step on the whole necessitates the confrontation of different points of views. As to the SA-RT technique, users can follow rules or recommendations to the level of the coherency of the model, such as distinction between the different types of interfaces, numeration of processes and diagrams, minimal and maximal number of processes by diagram, etc. One intends, by coherency application of the

heritage rule i.e. when data are placed at a decomposition level N, it is explicitly or implicitly present at the inferior levels.

However, a complementary mean to check coherency of diagrams is a confrontation between the context diagram, the data flow diagrams and the control flows diagram.

We present the results of the SA-RT method in a situation of an application of a SCADA system on a hydrogen station of a TPP [28]. In this situation, the SCADA system assures the interfacing between the debit meters of hydrogen and stations of surveillance in the control room of the TPP. This interfacing is assured by different modules and interfacings that transform the signal of exit of the debit

meter that is an analogical signal (4-20mA) in a numeric signal.

In fact, the TPP arranges a regulator of pressure that assures the feeding of H<sub>2</sub>. When the uncommunicative gas in the alternator and the pressure is increased the regulator will be stopped. The value of gas hydrogen flights is not displayed on the SCADA system.

To remedy this problem, we propose an automatic reading of the value of the gas hydrogen flights. The proposed solution is to make the calculation of flights by the SCADA system and to program blocks of the daily calculation.

For the example, we present the control flow diagram of the application of the SCADA system in a hydrogen station.

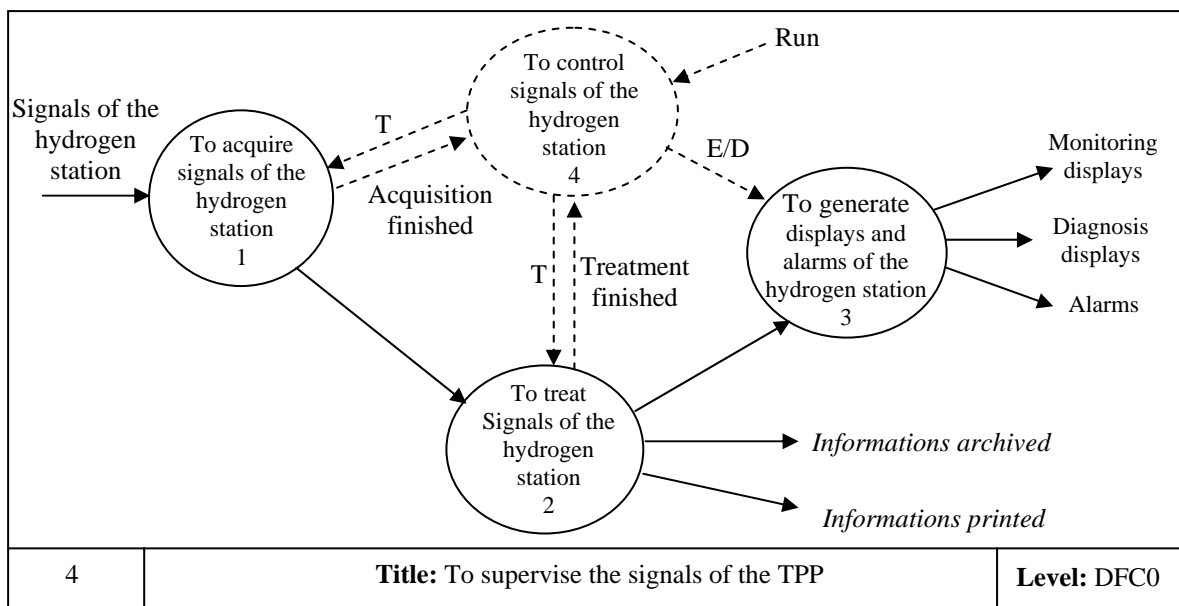

Fig. 9. Control Flows Diagram of the SCADA system.

In order to give a detailed vision of the control of the hydrogen station, we present the State/Transition diagram (Fig.10).

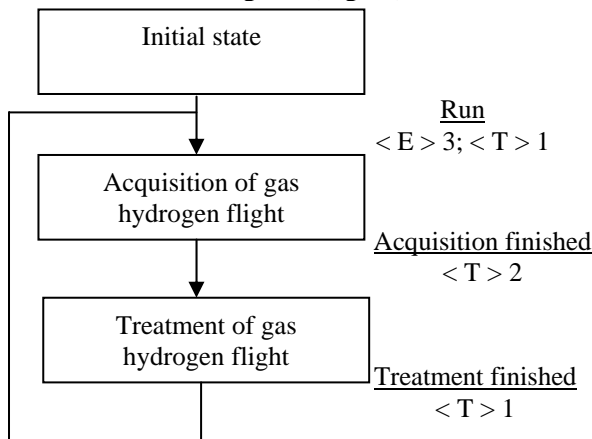

Fig. 10. State/Transition diagram of the SCADA system.

Compared to the results given by other methods such as SADT (Structured Analysis

Design Technique), the SA-RT method allows a functional as well as a temporal analysis.

The possible uses for the SA-RT model are the design of a monitoring display and a diagnosis display. For the design of a monitoring display, the preliminary data flow diagram of the SA-RT model supplies a global view of the system. Indeed, information relative to each process represented through this level should appear in a monitoring display.

For the design of hierarchical diagnosis display, each data flows diagram of the SA-RT model constitutes a vision at a given abstraction level. So, each of these data flows diagrams gives a less or more detailed vision. In function of the objectives defined by the designer for each display, a particular data flows diagram can supply the required information.

Finally, this application of the FA technique on the SCADA system of a TPP shows briefly

the interests of the SA-RT method in the design of supervisory systems.

## 5. Conclusion

In this paper, the application of SA-RT method on a real system, a SCADA system of a thermal power plant generates a source of useful information for the design of a supervisory system (monitoring and diagnosis displays, definition of alarms, etc.). So, research into the application of FA techniques for the design of a human centered supervisory system must be intensified in order to solve several difficulties and to improve their efficiency (tools to build the model, tools to check the validity of the model, etc.).

In the design of a supervisory system, the difficulty lies in the capacity to represent both the process faithfully and to provide for the designers usable information. To reach this objective, FA techniques seem to be a promising way because the major advantage of these kinds of techniques is due to the concept of function and abstraction hierarchy which are familiar to the human operator. These techniques permit the complexity of a system to be overcome.

## References

1. Lambert M., Riera B., Martel G., Application of functional analysis techniques to supervisory systems, *Reliability Engineering and System Safety* 64, 1999, pp 209–224.
2. Millot P., Supervision des procédés automatisés et ergonomie, Paris, France, Hermès, 1988.
3. Wiles J., Techno Security's Guide to Securing SCADA: A Comprehensive Handbook On Protecting The Critical Infrastructure, Elsevier, 2008.
4. Warcuse J., Menz B., Payne J. R., Servers in SCADA applications, *IEEE Trans. Ind. Appl.* 9 -2, 1997, pp 1295-1334.
5. Bailey D., Wright E., Practical SCADA for Industry, Elsevier, 2003.
6. Clarke G., Reynders D., Wright E., Practical Modern SCADA Protocols, Elsevier, 2003
7. Gergely E.I., Coroiu L., Popentiu-Vladicescu F., Analysis of the Influence of the Programming Approach on the Response Time in PLC Programs, *Journal of Computer Science and Control Systems*, 3(1), 2010, pp 61-64.
8. Gergely E.I., Coroiu L., Gacsadi A., Design of Safe PLC Programs by Using Petri Nets and Formal Methods, 11th WSEAS International Conference on Automation & Information, Romania, June 13-15, 2010, pp 86-91.
9. Lakhoua M.N., Application of Functional Analysis on a SCADA system of a Thermal Power Plant, *Advances in Electrical and Computer Engineering journal*, Issue No2/2009, vol. 9.
10. Lakhoua M.N., SCADA applications in thermal power plants, *International Journal of the Physical Sciences, Academic Journals*, vol.5, N°7, 2010, pp 1175-1182.
11. Poon H.L., Applications of Data Acquisition Systems, *Computers in Industry* 13, 1989, pp 49-59.
12. Ozdemir E., Karacor M., Mobile phone based SCADA for industrial automation, *ISA Transactions*, vol.45, Number 1, January 2006, pp 67–75.
13. Horng J.H., SCADA system of DC motor with implementation of fuzzy logic controller on neural network, *Advances in Engineering Software* 33, 2002, pp 361-364.
14. Aydogmus Z., Implementation of a fuzzy-based level control using SCADA, *Expert Systems with Applications*, article in press, 2008.
15. Munro K., SCADA - A critical situation, *Network Security*, Volume 2008, Issue 1, January 2008, pp 4-6.
16. Patel M., Cole G. R., Pryor T. L., Wilmota N. A., Development of a novel SCADA system for laboratory testing, *ISA Transactions* 43, 2004, pp 477-490.
17. Ralston P.A.S., Graham J.H., Hiebb J.L., Cyber security risk assessment for SCADA and DCS networks, *ISA Transactions* 46, 2007, pp 583-594.
18. Avlonitis S.A., Pappas M., Moutesidis K., Avlonitis D., Kouroumbas K., Vlachakis N., PC based SCADA system and additional safety measures for small desalination plants, *Desalination* 165, 2004, pp 165-176.
19. Gomaa H., Software design methods for the design of large-scale real-time systems, *Journal of Systems and Software*, vol. 25, Issue 2, pp 127-146, 1994.
20. Jaulent P., Génie logiciel les méthodes : SADT, SA, E-A, SA-RT, SYS-P-O, OOD, HOOD, Armand Colin, Paris, 1992.
21. Sommerville I., Le génie logiciel et ses applications, InterEditions, France, 1988.
22. Strohmeier A., Buchs D., Génie logiciel : principes, méthodes et techniques, Presses polytechniques et universitaires Romandes, Lausanne 1996.
23. Urbain L., Tondu B., Robot controller specification using SART approach, *Proceedings of the Third IEEE Conference on Control Applications*, 1994, pp 303-308.
24. Ryan J., Heavey C., Process modeling for simulation, *Computers in Industry*, vol. 57, 2006, pp 437-450.
25. Sahraoui, N., Applying specification methods to complex systems, *International Conference on Systems, Man, and Cybernetics*, vol.5, 1997, pp 4488-4491.
26. Lakhoua M.N., Review of Structured Analysis and System Specification methods, *Journal of Electrical Engineering*, vol.10, N°2, 2010.
27. Lakhoua M.N., Approach of analysis of the structured methods used for real time applications, *Journal of Computer Science and Control Systems*, vol.3, N°1, 2010.
28. Lakhoua M.N., Application of a SCADA system on a hydrogen station, *Journal of Electrical Engineering*, vol.10, N°3, 2010.