

# PLACEMENT OF ACTIVE POWER LINE CONDITIONER IN DISTRIBUTION SYSTEM USING DIFFERENTIAL EVOLUTION

**Dr.D.KAVITHA**

Department of Electrical & Electronics Engineering, Thiagarajar college of Engineering, Madurai  
Email : dkavitha@tce.edu

***Abstract**—Active Power Line Conditioners (APLCs) are considered the most efficient device for mitigation of power system harmonics. In this paper, a problem of allocation and sizing of multiple active power-line conditioners (APLCs) in distorted power distribution systems is handled with novel formulation. The utilized objective function comprises two main factors such as reduction of total harmonic distortion and the total cost of APLCs. The formulated problem is solved by four different optimization techniques GA, PSO, Hybrid GA-PSO and DE. To evaluate the competence of the proposed formulation, the IEEE 18-bus and 69 bus distorted distribution test systems are employed and investigated with various number of APLCs placement. These cases are based on the discrete and limited size for APLCs, requiring the optimization method to solve the constrained and discrete nonlinear problems. Therefore, all the evolutionary algorithms used utilize an integer optimizer. Simulation results confirmed the capability and effectiveness of the proposed formulation and DE algorithm works well in the allocation and sizing of multiple APLCs in a test power system compared with other heuristic algorithms.*

***Index Terms**—Active power-line conditioner (APLC), genetic algorithm (GA), harmonics, particle swarm optimization (PSO), Differential evolution, Distorted distribution system.*

## I. INTRODUCTION

The APLC is converter based compensation device and it is designed to improve the power quality of the entire distribution system by injecting corrective harmonic current at selective buses. APLC units can be considered as a group of shunt active filters. Their placement, sizing and compensation levels (e.g., orders, magnitudes and phases of injected current harmonics) are optimally designed to improve the power quality of the entire distribution system.

The number of required APLC units depends on the severity of distortion, the nature of the distribution system and the type of nonlinear loads as well as the quality of electric power.

Passive filters are employed because they are simple and profitable. Even then, active power line conditioner is considered the most efficient device for mitigating harmonic level. The advantages of active power line conditioners are well established in literatures. Even though much advantages are there, installation of active power line conditioners in a power distribution system is not a easy task. The harmonic standard, locations and sizes of APLCs, as well as the injection currents spectra of APLCs must be thoroughly considered. In addition, the sizes of the commercially available APLCs have discrete values. Despite a large number of benefits provided by APLCs, their huge installation and operation costs prevent electrical engineers from employing these profitable instruments without any restriction at all buses in power distribution systems.

Hence, in a large distribution system, it becomes necessary to locate suitable places for APLC installation to reduce these distortions and fixing their sizes is also essential. Considering this truth, a variety of solution methodologies have been utilized to solve the APLCs allocation and sizing problem. Initially network objective functions are applied for actively minimizing the impact of voltage harmonics in power systems using APLC [1,2]. The necessity of APLC in meeting IEEE-519 harmonic voltage and voltage distortion constraints is also illustrated. In these works, single APLC is placed on the distorted distribution system. Using only one APLC may not guarantee satisfaction of the harmonic limits at all buses if many nonlinear loads are present in a power system. This necessitates solving the OASA problem in distribution networks with different formulations and algorithms.

The requirement of multiple APLCs in a power system to control harmonic voltage and THD is then depicted [3]. Chang & Grady have proposed multiple APLCs which are current-constrained for minimizing harmonic voltage distortion [4]. The same authors have extended the similar work for three phase APLC planning [5]. Enhanced optimal harmonic power flow method is utilized to reduce harmonic power flow calculation complexity for APLC planning [6]. Chang HC & Chang TT

have proposed gradient method along with differential evolution for placing and sizing APLC in order to reduce harmonic voltage distortion in distribution systems [7]. Similar work is done in unbalanced distribution systems and optimal installation of three-phase APLCs is done in three phase unbalanced system [8]. Genetic based algorithm have been proposed for active power filter allocation and sizing [9]. The purpose of this approach is to minimize the total injection currents of APLCs, while satisfying harmonic standards and practical constraints such as the individual harmonic voltage distortion, total harmonic voltage distortion limits, and the commercially available discrete sizes of the APLCS. Iman Ziari et al have presented a PSO algorithm for allocation and sizing of multiple Active Power Line Conditioners (APLCs) in power systems [10]. They considered the objectives of minimizing the APLC rating as well as THD.

In these works, the cost of APLC is not considered. The realistic investment cost of an APLC is separated into two different parts, constant cost and the incremental cost. The constant cost, called fixed installation cost, is constant and is not related to the APLC rating. The incremental cost, e.g. the purchase cost, is proportional with the APLC rating. If APLC rating is the objective to be minimized, it indirectly results in ignoring the fixed installation cost. This assumption influences the results and leads the optimization method to result in use of a number of APLCs with higher investment cost.

Also, In all these works, the standard IEEE 18 bus distorted distribution system is taken for the case study and in this system, the non linear loads occurs at only at three to five buses. Hence the problem convergence is fast and the allocation of APLC units falls within these buses. The increase of nonlinear loads (NLLs) in supply networks has led to an increase of harmonic content in supply currents. Thus practically, the sizes of non linear loads are increasing greatly and cannot be restricted to limited number of buses. Hence in this work, it is considered about 11 buses are having non linear loads and the APLC placement may be in any of the 18 buses.

Iman Ziari et al have considered the problem with the objective of cost minimization of APLCs [11]. The fixed cost of an APLC is taken as 90000\$ and the incremental cost of an APLC is taken as 720000\$ per 1 pu [12]. Using these values, the realistic investment cost of APLC is calculated. The objective function is the investment cost of APLCs and the constraints are voltage THD and the individual voltage harmonic distortion which should be maintained less than 5% and 3%, respectively. Hence in this work, APLCs placement and sizing are evaluated for a distorted distribution system considering two main objectives such as reduction in THD as well as APLC cost under the presence of more number of non linear load buses

## II. PROBLEM FORMULATION

The APLC is modeled as a set of current sources which inject current with different order of harmonics to the point of common coupling. The phasor model of APLC used in this work is given in (1)

$$I_{F,m}^h = I_{F,m}^{h,r} + jI_{F,m}^{h,i} \quad (1)$$

Where

$I_{F,m}^h$  APLC current at bus  $m$  for harmonic order  $h$ ;

$I_{F,m}^{h,r}$  Real part of APLC current at bus  $m$  for harmonic order  $h$  ;

$I_{F,m}^{h,i}$  Imaginary part of APLC current at bus  $m$  for harmonic order  $h$  ;

The indices  $r$  and  $i$  represent the real and imaginary parts of the APLC current, respectively.

The objective is to minimize the total investment cost of APLCs and the total harmonic distortion that occur in the system. The constraints are individual harmonic distortion. THD is also introduced as one of the constraints. The investment cost of an APLC includes the constant cost and the incremental cost. The constant cost, called fixed installation cost, is constant and is not related to the APLC rating, e.g. the required cost for securing and purchasing land. The incremental cost, e.g. the purchase cost, is proportional with the APLC rating. The objective function is formulated as follows:

$$OF = \beta_1 OF_{THD} + \beta_2 OF_{COST} \quad (2)$$

Where  $\beta_1$  and  $\beta_2$  are weight factors.  $OF_{THD}$  can be formulated as follows :

$$OF_{THD} = \frac{\sum_{m=1}^M THD_m}{M} \quad (3)$$

$$THD_m = \frac{\sqrt{\sum_{h=2}^N |V_m^h|^2}}{|V_m^1|} \quad (4)$$

Where

$M$  – Total number of buses

$N$  - Maximum considered harmonic order

$V_m^h$  - Voltage at bus  $m$  for harmonic order  $h$

$THD_m$  - THD at bus  $m$

$OF_{COST}$  can be formulated as follows :

$$OF_{COST} = \sum_{m=1}^{NB} C_C + C_I S_{APLC_m} \quad (5)$$

Where

$C_C$  - Constant cost of APLCs

$C_I$  - Incremental cost of APLCs  
 $S_{APLC_m}$  - Rating of an APLC located at bus m which is proportional with its current.  
 NB - number of APLC buses

$$I_{F,m} = \sum_{h \in S_N} \left[ (I_{F,m}^{h,r})^2 + (I_{F,m}^{h,i})^2 \right]^{1/2} \in S_{size}; k \in S_{NB} \quad (6)$$

$S_N$  - The set of harmonic orders.  
 $S_{NB}$  - The set of bus installations of the APLCs.

$$S_{size} = \{I_b, 2I_b, \dots, \max I_b\} \quad (7)$$

$I_b$  - The base unit size of the APLC.  
 $\max I_b$  - Maximum size of the APLC.

The constraints are given as follows

$$\frac{|V_i^h|}{|V_i^1|} \leq V_{max}^h \quad i = 1, \dots, M; h \in S_N \quad (8)$$

Where (8) is the individual harmonic voltage distortion for each bus within the limit, and  $V_{max}^h$  is usually 3%. Equation 7 denotes that the sizes of APLCs are discrete in nature.

$V_i^h$  - The harmonic voltage at bus i for harmonic h.  
 $V_i^1$  - The fundamental frequency voltage at bus i.

Due to the occurrence of parallel resonance, the most serious voltage harmonic distortion may occur at those buses, where there is no nonlinear load but there is a capacitor installed. A bus where exists no nonlinear load but a high level of voltage harmonic distortion may not be the perfect candidate location to install APLCs to eliminate harmonics [7]. Also, the rating of APLC depends on the individual harmonic current injection into the bus by APLC. Hence, there is a possibility that, wrong current injections may lead to excessive rating of APLC as well as increase in THD levels. These are some of the reasons that make the problem with many local solutions and so, search space is wider.

### III. OPTIMIZATION TECHNIQUES PROPOSED FOR APLC PLACEMENT

Several optimization techniques have been presented by researchers to determine the optimal sizing and placement of Active Power Line Conditioner (APLC). Various optimization methods such as Genetic Algorithm (GA), Particle Swarm Optimization (PSO) and Differential evolution (DE) are used in this work. The steps used to solve the optimization problems using this algorithm are well established in literatures [13-16]. Hybrid PSO-GA (HPSOGA) is also proposed. In this method, the optimization algorithm uses PSO technique initially to update all the particles. Then, GA operators are applied. The

crossover and mutation operators are applied to half of the individuals and new population is created. This is done to increase the diversity of the optimizing variables to improve the local minimum problem.

The main steps of the HPSOGA algorithm are given below:

```

Initialization of particles
Evaluation
Repeat
  Compute Gbest and Pbest
  Update velocity
Update particles
For half of the population
{
  Selection
  Crossover
  Mutation
}
Evaluation
Until (termination criteria are met)
  
```

Comparing the results, DE algorithm is proposed for this problem of allocation and sizing of APLCs in distorted distribution system.

## IV. PROPOSED METHODOLOGY

The solution methods aim at determining optimal allocation and sizing of APLC. The problem solving involves load flow analysis, harmonic flow analysis and calculation of APLC cost for each feasible solution. Hence, Fundamental and Harmonic load flow analysis are integrated with the optimization technique, in order to obtain the fitness functions for the individual harmonic distortion and total harmonic distortion that occur in the distribution system. Load-Flow studies are performed to determine the steady-state operation of an electric power system.

### 4.1 Load Flow Analysis

A load-flow study calculates the voltage drop in each feeder, the voltage at each bus, and the power flow in all branch and feeder circuits. The conventional methods for load flow analysis include Single-Line Equivalent Method, Very Fast Decoupled Method, Ladder Technique, Power Summation Method and Backward and Forward Sweeping Method. An effective approach proposed for distribution power flow solutions [17] is utilized in this work. The special topological characteristics of distribution networks have been fully utilized to make the direct solution. Two matrices namely the Bus-Injection to Branch-Current matrix

(BIBC) and the Branch-Current to Bus Voltage matrix (BCBV) are used to obtain power flow solutions.

For distribution networks, the equivalent current injection based model is more practical. For bus  $i$ , the complex load 'S<sub>i</sub>' is expressed by

$$S_i = P_i + j Q_i \quad (9)$$

Where  $i = 1, 2, 3, \dots, M$

And the corresponding equivalent current injection at the  $k^{\text{th}}$  iteration of solution is

$$I_i^k = (P_i + j Q_i) / V_i^{k*} \quad (10)$$

Where  $V_i^k$  and  $I_i^k$  are the bus voltages and equivalent current injection of bus  $i$  at  $k^{\text{th}}$  iteration, respectively.

A simple distribution network shown in Figure 1 is noted as an example to illustrate the used method.

The relationship between bus currents and branch currents can be obtained by applying Kirchhoff's current law (KCL) to the distribution network. Then, the branch currents are formulated as functions of equivalent current injections. For example, the branch currents  $B_1$ ,  $B_3$  and  $B_5$  can be expressed by equivalent current injection as

$$B_1 = I_2 + I_3 + I_4 + I_5 + I_6 \quad (11a)$$

$$B_3 = I_4 + I_5 \quad (11b)$$

$$B_5 = I_6 \quad (11c)$$

Therefore, the relationship between the bus current injections and branch currents can be expressed as,

$$\begin{bmatrix} B_1 \\ B_2 \\ B_3 \\ B_4 \\ B_5 \end{bmatrix} = \begin{bmatrix} 1 & 1 & 1 & 1 & 1 \\ 0 & 1 & 1 & 1 & 1 \\ 0 & 0 & 1 & 1 & 0 \\ 0 & 0 & 0 & 1 & 0 \\ 0 & 0 & 0 & 0 & 1 \end{bmatrix} \begin{bmatrix} I_2 \\ I_3 \\ I_4 \\ I_5 \\ I_6 \end{bmatrix} \quad (12)$$

Eq. (12) can be expressed in general form as

$$[B] = [BIBC] * [I] \quad (13)$$

Where BIBC is a bus injection to branch current matrix and the BIBC matrix is a upper triangular matrix which contains 0's and 1's only. Similarly, the relation between branch currents and bus voltages is given by the equation 16.

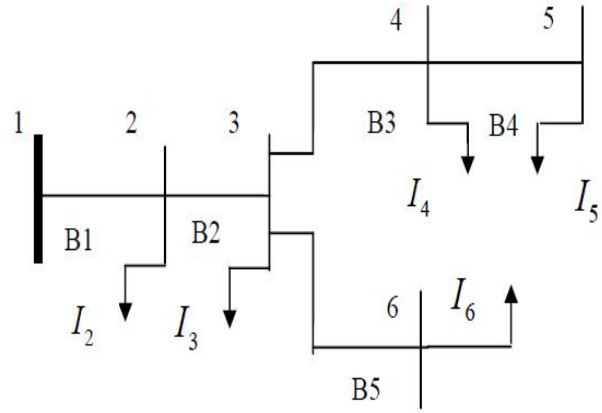

Figure 1 Simple distribution system

$$\begin{bmatrix} V_1 \\ V_1 \\ V_1 \\ V_1 \\ V_1 \end{bmatrix} - \begin{bmatrix} V_2 \\ V_3 \\ V_4 \\ V_5 \\ V_6 \end{bmatrix} = \begin{bmatrix} Z_{12} & 0 & 0 & 0 & 0 \\ Z_{12} & Z_{23} & 0 & 0 & 0 \\ Z_{12} & Z_{23} & Z_{34} & 0 & 0 \\ Z_{12} & Z_{23} & Z_{34} & Z_{45} & 0 \\ Z_{12} & Z_{23} & 0 & 0 & Z_{56} \end{bmatrix} \begin{bmatrix} B_1 \\ B_2 \\ B_3 \\ B_4 \\ B_5 \end{bmatrix} \quad (14)$$

$$[\Delta V] = [BCBV][B] = [BCBV][BIBC][I] = [DLF][I] \quad (15)$$

Where DLF is Distribution load flow matrix.

$$[\Delta V_{k+1}] = [DLF][I_k] \quad (16)$$

$$[V_{k+1}] = [V_0] + [\Delta V_{k+1}] \quad (17)$$

## 4.2 Harmonic load flow and optimization

In this paper, conventional harmonic power flow method is used and is given by (18).

$$V_{bus}^h = (1/(Y_{bus}^h)) \times I_{bus}^h \quad (18)$$

Thus, the bus voltage for all harmonic orders is calculated by multiplying the injecting currents and the impedance matrix, Where  $V_{bus}^h$  and  $I_{bus}^h$  are the bus voltages and the injecting current vectors for  $h^{\text{th}}$  harmonic order, respectively.  $Y_{bus}^h$  is the admittance matrix for  $h^{\text{th}}$  harmonic order and is determined for all the harmonics orders under consideration. The admittance matrix is formed using direct inspection method [18].

In this procedure, the net current injected to buses,  $I_{bus}^h$ , is obtained using the following equation:

$$I_{bus}^h = I_{APLC}^h - I_{NLD}^h \quad (19)$$

Where  $I_{NLD}^h$  and the  $I_{APLC}^h$  are injecting current vectors related to the nonlinear loads and APLCs, respectively.

The APLC currents are modified using Equations 20 and 21 to convert it as a discrete structure using integer optimizer.

$$I_{APLC_m} = I_{APLC_m} \times K_{C_m} \quad (20)$$

$$K_{C_m} = \frac{I_b \times \text{round}\left(\frac{I_{APLC_m}}{I_b}\right)}{I_{APLC_m}} \quad (21)$$

Here 'round' will convert the float variable to the nearest integer.  $K_{C_m}$  is a correction factor to correct the rating of the APLC located at bus  $m$  as integer multiples of Base Unit Rating ( $I_b$ ) of APLCs. As mentioned,  $I_b$  is assumed to be 0.01p.u.

The common algorithm for the various techniques is explained briefly below:

Step 1 Input system data and initialization of algorithm parameters. The number of optimizing variables is number of candidate buses plus the number of candidate buses multiplied by harmonics orders considered.

Step 2 The optimizing variables with the population size of  $np$  are created which include the location and current injection at each APLC buses for all the harmonics order considered. The real and imaginary parts of APLC are modified using Equation 20 and 21 to convert into the integer multiples of base rating of APLC

Step 3 The currents injecting to buses are calculated using Equation 19.

Step 4 Harmonics voltages at each bus are determined using the Equation 18.

Step 5 Using bus voltages and currents values, objective functions, cost of APLC and THD are calculated using the Equation 2.

Step 6 Constraints are calculated and incorporated in the objective function value using penalty less constraint handling method.

Step 7 The optimizing variables of the whole population are updated using the application of corresponding algorithm operators.

Step 8 Check convergence criteria. If iteration is less than the maximum iterations considered, then go to step 2. Otherwise, stop the program and take the best results.

## V. RESULTS AND DISCUSSIONS

The algorithms are developed in MATLAB software. The IEEE distorted 18-bus and 69 bus distorted distribution systems are employed as the test systems. The parameters used for various algorithms are as follows:

GA: Tournament selection, Simulated Binary crossover with crossover index= 15 and Polynomial mutation.

PSO: The acceleration constants  $C1=2$  and  $C2=2$ ; Inertia weight = 0.2 minimum and 0.9 maximum.

HPSOGA: GA and PSO parameters altogether.

DE: the crossover constant  $Cr = 0.75$ , the mutation scale factor  $F=0.5$ .

As the number of variables is very high in this problem, the population size  $np= 250$  and the stopping criteria is the total number of generation.

### 5.1 18-Bus Distribution System

In this case, the modified IEEE 18-bus system [11] is used as a test system. The base voltage is 12.5 kV and base power is 10 MVA. In this system, 16 buses (Bus No

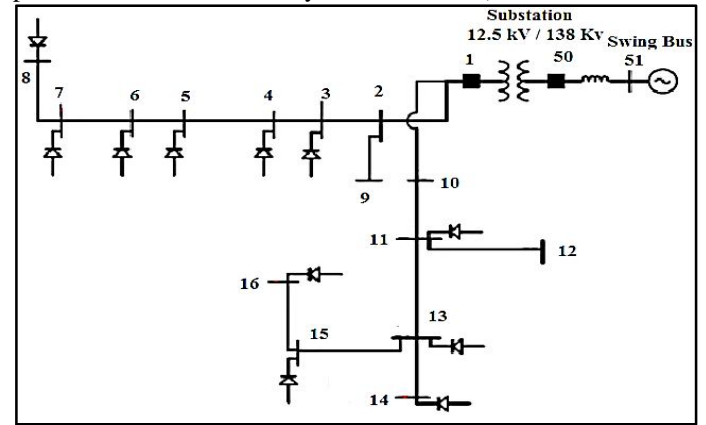

Figure2 18 bus test system configuration

number 1 to 16) are assumed as candidate for installation of APLCs

The bus and line data are provided in Appendix. The nonlinear loads are modeled as identical harmonic current sources. In this system, eleven identical harmonic current sources are employed as nonlinear loads and located at buses 3,4,5,6,7,8,11,13,14,15,16. The harmonic contents of the employed harmonic current sources (the nonlinear loads) are shown in Figure 3. Eight harmonic orders such as 5<sup>th</sup>, 7<sup>th</sup>, 11<sup>th</sup>, 13<sup>th</sup>, 17<sup>th</sup>, 19<sup>th</sup>, 23<sup>rd</sup> and 25<sup>th</sup> are considered

Before the installation of APLC, the base case analysis is done. The fundamental voltage profile of the distribution system is determined using Equations 9 to 17. The iterative algorithm repeats calculation of these equations until convergence occurs. The fundamental voltage profile of the system is shown in Figure4

The admittance matrix for each harmonics is calculated using the line data of the system. Then, harmonic Voltages for the considered eight orders at each bus are

calculated using equations (18) and (19). Thus, Voltage distortions for all harmonic orders as well as THD at all buses are calculated by using the admittance matrix for all

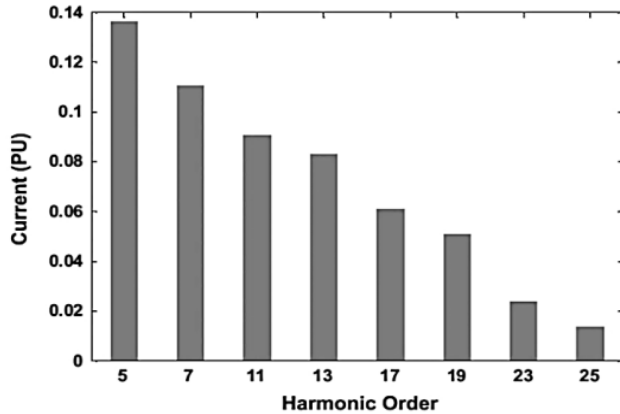

Figure 3 Harmonic contents of used nonlinear loads

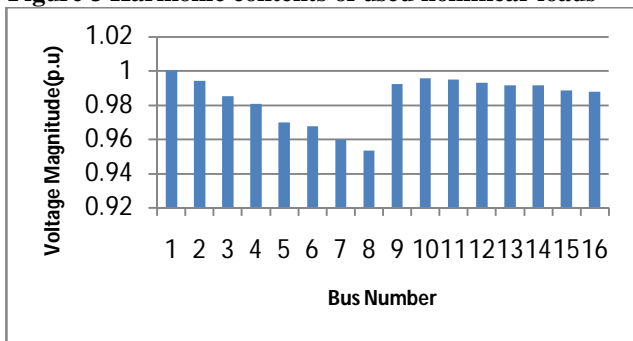

Figure 4 Voltage magnitude in distribution system

Harmonic orders and the harmonic contents of nonlinear loads. It should be noted that since no APLC is installed, APLCs current injection matrix in Equation (19) is considered as a zero matrix. Table 1 gives the THD at all the buses, when no APLC is installed

From Table 1, the average THD at all buses is 12.548% which represents an unallowable harmonic distortion level regarding to the IEEE standard (the standard limit is 5%).

The maximum THD occurs at bus 16. It has high voltage THD level of 17.585%. If only the non linear load current spectrum is considered for placement of APLC, APLCs are to be installed in all the non linear load buses with the rating of 0.233p.u. Hence, 11 APLCs with rating about 0.24 pu (nearest discrete value) should be placed at each non linear load buses [11].

Table 1 THD at different buses in no APLC state

Bus number	THD (%)
1	12.691
2	11.727
3	9.6681
4	8.8692
5	8.1307
6	8.5097
7	8.5614
8	8.6749
9	11.773
10	13.716
11	14.974
12	15.009
13	16.672
14	16.776
15	17.437
16	17.585
<b>Average</b>	12.548
<b>Maximum</b>	17.585

This results in huge investment cost. If only base case analysis is considered without optimization method, the APLCs can be simply located at the nonlinear load buses with the same size of the corresponding nonlinear load and is provided in Table 2.

To reduce the total investment cost as well as THD, an optimization procedure is required to find the optimal placement and rating of APLCs in these type of distribution networks.

To make the problem more realistic, the APLC current rating is assumed as integer multiples of 0.01 p.u. For this purpose, the APLC currents are modified using Equations 20 and 21.

Table 2 APLC current rating without optimization

Bus number	APLC Rating(p.u)
1	0
2	0
3	0.02
4	0.09
5	0.2
6	0.12
7	0.01
8	0.02
9	0
10	0

11	0.03
12	0
13	0.07
14	0.07
15	0.06
16	0.02
<b>Total APLC Rating (p.u)</b>	0.53
<b>Average THD (%)</b>	0

To place APLCs in a distorted system, different strategies are considered. Number of APLCs to be commissioned is fixed. First, the number of APLCs is fixed as 5. In this case, the total number of variables to be optimized is  $5+(8 \times 5) = 45$ .

The formulated optimization problem is solved by different algorithms and the solutions are obtained. The candidate buses for APLC installation given by GA are 5,7,8,13,15 constituting a total investment cost of 0.7236Million \$ with THD 4.4876%.

The total APLC rating corresponding to the solution is 0.38. Then, GA is used to find the optimal buses, if number of APLCs are 4,3,2 and 1. There is no convergence observed while running GA, if number of APLC buses=3,2 and 1. To obtain the solution, the relaxation is given to THD constraint. Table 3 shows the parameters obtained after optimal placement of APLC in the 18 bus distribution system by Genetic Algorithm. From the results of GA, it is observed that minimum four numbers of APLCs are required to keep THD within the limits in this system.

Based on GA, the optimal solution is to provide 4 APLC at buses 13,7,6 and 8, respectively to handle the worst harmonic polluted case. In that case, the average THD is 4.7824%, the current injected by APLC is 0.34 p.u and the total investment cost is  $6.0480 \times 10^5$  \$.

Similar results are obtained using PSO, Modified HPSOGA, and DE. Table 4 states the parameters obtained after optimal placement of APLC in the 18 bus distribution system by PSO Algorithm

According to PSO, the optimal solution is to provide 4 APLC at buses 7, 8, 13 and 15, respectively to handle the worst harmonic polluted case. In that case, the average THD is 4.5720, the current injected by APLC is 0.30p.u and the total investment cost is  $5.7600 \times 10^5$  \$.

Table 5 gives the parameters obtained after optimal placement of APLC in the 18 bus distribution system by HPSOGA Algorithm.

**Table 3 Solution of GA algorithm to install APLCs in 18 bus distribution system**

Number of APLC	Location	Average THD (%)	Investment Cost (\$)	Total APLC Rating (p.u)
5	5,15,13,7,8	4.4876	$7.2360 \times 10^5$	0.38
4	13,7,6,8	4.7824	$6.0480 \times 10^5$	0.34
3	11,6,5	5.5436	$4.9320 \times 10^5$	0.31
2	7,16	6.4692	$3.4560 \times 10^5$	0.23
1	13	6.5822	$1.7640 \times 10^5$	0.12

**Table 4 Solution of PSO algorithm to install APLCs in 18 bus distribution system**

Number of APLC	Location	Average THD (%)	Investment Cost (\$)	Total APLC Rating (p.u)
5	7,15,4,6,5	4.2286	$6.8760 \times 10^5$	0.33
4	7, 8, 3 15	4.5720	$5.7600 \times 10^5$	0.30
3	4, 13, 8	5.8086	$4.7160 \times 10^5$	0.28
2	4, 5	6.0476	$3.3120 \times 10^5$	0.21
1	15	6.2499	$1.8360 \times 10^5$	0.13

**Table 5 Solution of HPSOGA algorithm to install APLCs in 18 bus distribution system**

Number of APLC	Location	Average THD (%)	Investment Cost (\$)	Total APLC Rating (p.u)
5	11,6,4,8,5	4.1286	$6.8040 \times 10^5$	0.32
4	5,6,8,3	4.3988	$5.5440 \times 10^5$	0.27
3	7,3,6	5.6239	$4.4280 \times 10^5$	0.24
2	13,5	5.9235	$3.2400 \times 10^5$	0.20
1	14	6.1475	$1.7640 \times 10^5$	0.12

From the results of HPSOGA, the optimal solution is to provide 4 APLC at buses 5, 6, 8 and 3, respectively to handle the worst harmonic polluted case. In that case, the average THD is 4.3988, the current injected by APLC is 0.27p.u and the total investment cost is  $5.5440 \times 10^5$  \$. Finally for DE algorithm, the optimal solution is to provide 4 APLC at buses 4, 7, 13 and 16, respectively to handle the worst harmonic polluted case. In that case, the average THD is 4.2097 %, the current injected by APLC is 0.20 p.u and

the total investment cost is  $5.0400 \times 10^5$  \$. The solution for placement and sizing of APLCs in 18 bus distribution system by DE algorithm is given in Table 6.

The variation of THD and cost with increase in APLC numbers according to DE algorithm are given in Figure5. Based on optimization procedures, the optimal solution is to allocate 4 APLCs to handle the worst harmonic polluted case

The APLCs placement and sizing are done for the worst harmonic polluted case and hence, the solutions are reliable even if the non linear loads inject lower harmonic currents. The comparison is provided in Table 7

Due to the presence of nonlinear load, the average THD is 12.548% without installation of APLC. Every algorithm yields particular solution based on their search strategies because of the wider search space and the presence of too many local solutions

**Table 6 Solution of DE algorithm to install APLCs in 18 bus distribution system**

Number of APLC	Location	Average THD (%)	Investment Cost (\$)	Total APLC Rating (p.u)
5	5,8,16,13,7	4.0257	$6.3720 \times 10^5$	0.26
4	4,7,13,16	4.2097	$5.0400 \times 10^5$	0.20
3	7,8,5	5.0194	$3.9240 \times 10^5$	0.17
2	16,5	5.8675	$2.8800 \times 10^5$	0.15
1	16	6.0241	$1.6920 \times 10^5$	0.11

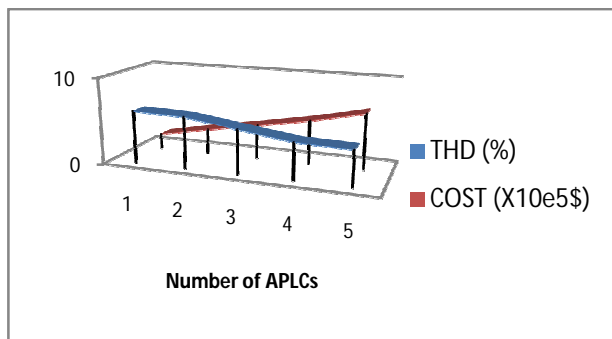

**Figure5 The variation of THD and Cost with increase in APLC numbers**

**Table 7 Comparison of APLC placement using various algorithms**

Parameters	With out APLC	With APLC			
		GA	PSO	HPSO GA	DE
Location of APLC	-	13, 7, 6, 8	7, 8, 3 15	5, 6, 8, 3	4, 7, 13, 16
Average THD (%)	12.548	4.7824	4.5720	4.39884	4.2097
APLC Rating (p.u)	-	0.34	0.30	0.27	0.20
Investment Cost (\$)	-	$6.0480 \times 10^5$	$5.7660 \times 10^5$	$5.5440 \times 10^5$	$5.0400 \times 10^5$

The rating depends on the individual harmonic current injection into the bus by APLC.. Hence, there is a possibility that wrong current injections may lead to excessive rating of APLC and increased THD levels

Due to the presence of nonlinear load, the average THD is 12.548% without installation of APLC. Every algorithm yields particular solution based on their search strategies because of the wider search space and the presence of too many local solutions. The rating depends on the individual harmonic current injection into the bus by APLC. Hence, there is a possibility that wrong current injections may lead to excessive rating of APLC and increased THD levels

After the optimal placement of APLC in the system, the average total harmonic distortion in GA optimization technique is 4.7824 %, in PSO technique it is 4.5720 %, in HPSOGA it is 4.3984 % and in DE technique it is 4.2097 %. The APLC rating is proportional to its current. The current injected by APLC in GA is 0.33861 p.u, in PSO it is 0.29849 p.u, in HPSOGA it is 0.26380 p.u and in DE technique it is 0.19212 p.u. The APLC cost is proportional with its rating. The total investment cost of APLC in Genetic algorithm is more compared to other algorithms such as Particle swarm optimization, Hybrid PSO-GA and Differential Evolution algorithm. The Figures from 6 to 9 gives the convergence characteristics of GA, PSO, HPSOGA and DE respectively for Modified IEEE 18 bus distribution system. The Figures from 10 to 13 show the individual APLC rating at identified



buses in the modified IEEE 18 bus system using various algorithms applied to solve OASA problem in this work.

Comparing the results to the solution obtained by Iman Ziari(2012), it is observed that the non linearity of the problem increases fatefully, if the number of APLC is decided by the algorithm Also the size of individual APLC should be kept small to minimize the investment cost.

3,4,7,14,15 with total APLC cost of 1.5M\$ using modified discrete PSO which is very high compared to the solution obtained by DE.

Figures 10 to 13 show the individual rating of APLC solved by various algorithms

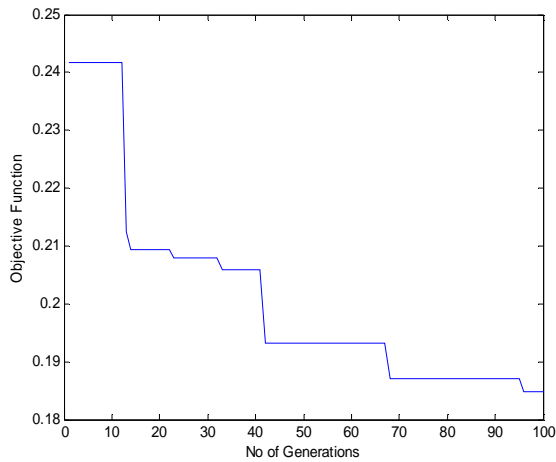

**Figure 6 Convergence characteristics of GA solving OASA with 4 number of APLCs in IEEE 18 bus distorted distribution system**

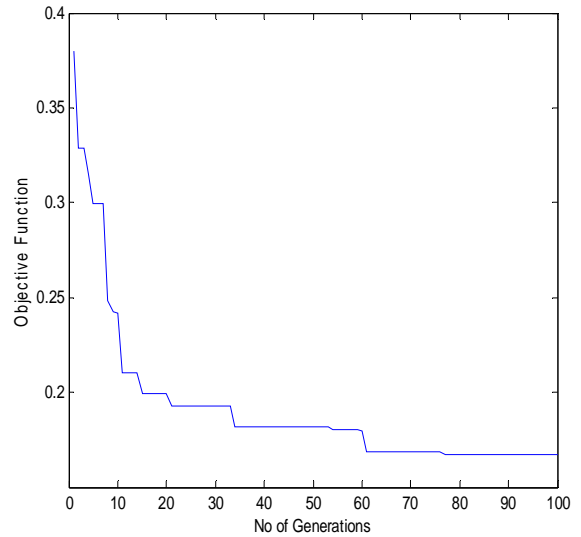

**Figure 8 Convergence characteristics of HPSOGA solving OASA with 4 number of APLCs in IEEE 18 bus distorted distribution system**

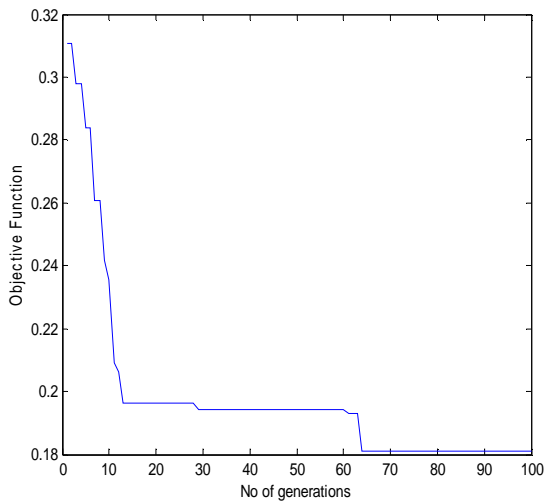

**Figure 7 Convergence characteristics of PSO solving OASA with 4 numbers of APLCs in IEEE 18 bus distorted distribution system**

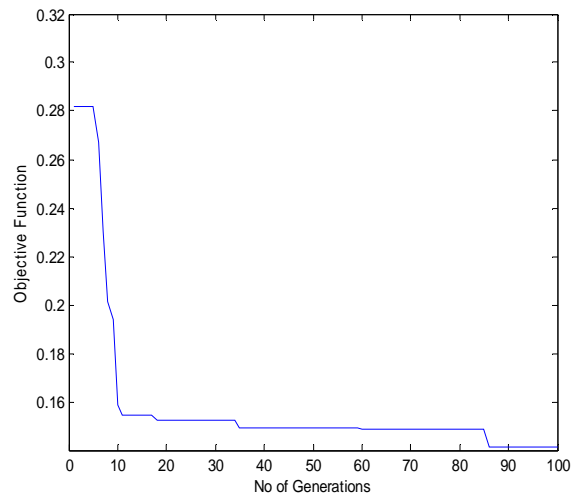

**Figure 9 Convergence characteristics of DE solving OASA with 4 number of APLCs in IEEE 18 bus distorted distribution system**

Iman Ziari(2012) has proposed APLC discrete size as 0.05 and obtained a solution of APLC installation at buses

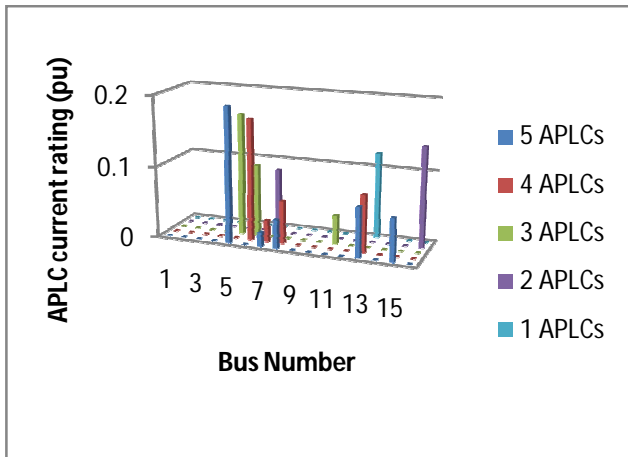

Figure 10 Individual APLC rating in IEEE 18 bus system obtained using GA

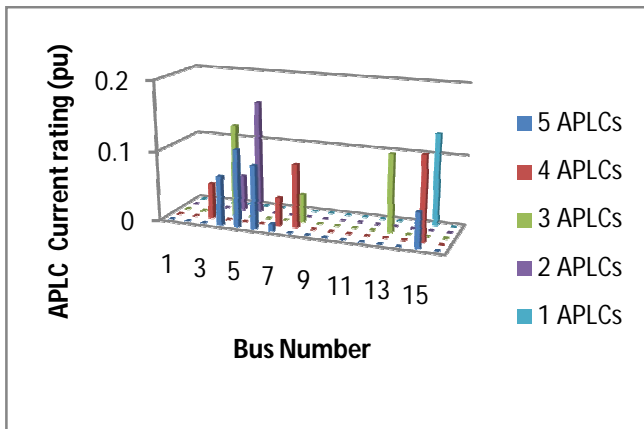

Figure 11 Individual APLC rating in IEEE 18 bus system obtained using PSO

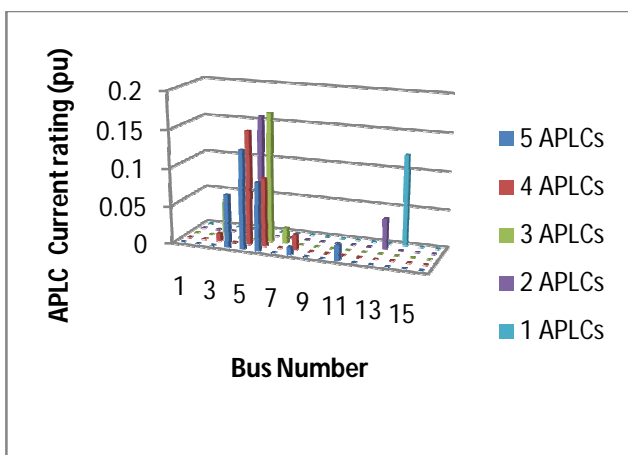

Figure 12 Individual APLC rating in IEEE 18 bus system obtained using HPSOGA

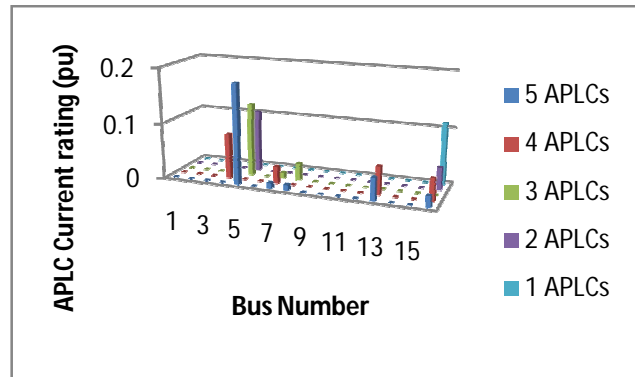

Figure 13 Individual APLC rating in IEEE 18 bus system obtained using DE

## 5.2 69 Bus Distribution System

For further analysis, the IEEE 69-bus distribution system shown in Figure 6 is taken as a test system. The total system load is 3.8MW and 2.69MVar. In this system, all the 69 buses are assumed as candidate for installation of APLCs. The bus and line data are provided

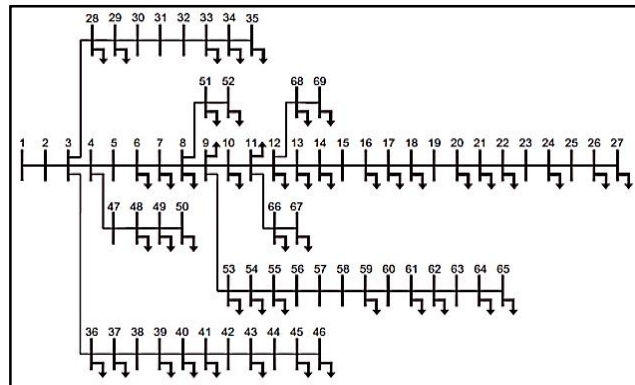

Figure 14 69 Bus Test System

Table 8 Harmonic contents of nonlinear loads

Harmonic order	Non-linear loads at bus 19, 30, 38, 57 (%)
5	68.3
7	47.8
11	0.2
13	6.1
17	4.2

in Appendix. Similar to the previous test system, the nonlinear loads are modeled as identical harmonic current sources. In this system, four identical harmonic current

sources are employed as nonlinear loads which are located at buses 19,30,38 and 57. Table 8 shows the harmonic contents of the employed harmonic current sources (the nonlinear loads).

Six harmonic orders such as 5<sup>th</sup>, 7<sup>th</sup>, 11<sup>th</sup>, 13<sup>th</sup> and 17<sup>th</sup> are considered in this case. Before the installation of APLC, the base case analysis is done. Though the non linear loads are located at buses 19,30,38 and 57, the higher THD values are observed at other buses also. The average THD at all buses is 17.586%. Hence, harmonic distortion level regarding to the IEEE standard is greatly violated. The maximum THD occurred in the bus 38 is 19.912%.

In this case, if only the non linear load current spectrum is considered for placement of APLC, APLCs are to be installed in all the non linear load buses with the rating of 0.83p.u. Hence, 4 APLCs with that rating should be placed at each non linear load buses. This results in huge investment cost. If base case analysis is only considered without optimization method, the APLCs can be simply located at the nonlinear load buses with the same size of the corresponding nonlinear load and is provided in Table 9. From the analysis of results obtained from various algorithms, the optimal solution is to allocate 2 APLCs to handle the worst harmonic polluted case. The objective parameters are calculated for both the cases with and without the installation of APLC in the test system and are shown in Table 10.

Due to the presence of nonlinear load, the average THD at all buses is 17.526 % in the case of without installation of APLC. After the optimal placement of APLC in the system, the average total harmonic distortion

**Table 9 APLC current rating without optimization**

Bus number	APLC Rating(p.u)
19	0.05
30	0.12
38	0.78
57	0.28
<b>Total APLC Rating (p.u)</b>	1.23
<b>Average THD (%)</b>	0

in GA optimization technique is 4.8033 %, in PSO technique it is 4.6309 %, in HPSOGA it is 4.4101 % and in DE technique it is 4.2736 %. The harmonic distortion is within the IEEE standard limit 5%. The APLC rating is proportional with its current. The current injected by active power line conditioner (APLC) in GA is 0.56 p.u, in PSO it

is 0.41 p.u, in HPSOGA it is 0.36 p.u and in DE technique it is 0.29 p.u

**Table 10 Parameters calculated with and without APLC**

Parameters	With out APLC	With APLC			
		GA	PSO	HPSO GA	DE
Location of APLC	-	19, 38	30, 38	57, 38	30, 57
Average THD (%)	17.526	4.8033	4.6309	4.4101	4.2736
APLC Rating (p.u)	-	0.56	0.41	0.36	0.29
Investment Cost (\$)	-	5.8320 *10 <sup>5</sup>	4.7520 *10 <sup>5</sup>	4.3920 *10 <sup>5</sup>	3.8880 *10 <sup>5</sup>

The total investment cost of APLC in Differential Evolution algorithm is less compared to other algorithms such as Particle swarm optimization, Hybrid PSO-GA and Genetic algorithm.

## VI .CONCLUSION

In this work, the problem of the optimal placement and sizing of Active Power Line Conditioner in distribution system is examined. The problem is formulated as a constrained nonlinear optimization problem. Differential Evolution (DE), Particle Swarm Optimization (PSO), Genetic Algorithm (GA) and Hybrid PSO-GA are used to obtain solutions for optimal allocation and sizing of Active Power Line Conditioner (APLC) in distribution systems. It is observed that the results obtained using DE are more encouraging compared to the results obtained from other heuristic approaches such as PSO, GA and HPSOGA.

There is a reduction of THD and total investment cost after placing APLCs with appropriate rating in appropriate buses. It is observed that, after optimal allocation of APLC in the distribution system, the APLC current rating is minimized and the cost gets reduced. The technical constraints such as THD and individual harmonic distortion at buses are maintained.

Optimal allocation of APLC is studied in IEEE 18 bus and 69 bus distorted distribution systems. The results are compared to the placement of APLCs in distorted distribution system without optimization. It is observed that choosing proper APLC rating and placement has a significant impact on minimizing the cost and total harmonic distortion. In 18 bus distribution system, it is found that DE algorithm additionally saves 0.05 to 0.1 M\$ when compared to all the other algorithms used. The savings in IEEE 69 bus system is about 0.05 to 0.2 M\$.

## VII. REFERENCES

- [1] Grady, WM & Samotyj, MJ 1992, 'The application of network objective functions for actively minimizing the impact of voltage harmonics in power systems', IEEE Transactions on Power Delivery, vol. 7, no. 3, pp. 1379–1386.
- [2] Chang, WK & Grady, WM 1994, 'Meeting IEEE-519 harmonic voltage and voltage distortion constraints with an active power line conditioner', IEEE Transactions on Power Delivery, vol. 9, no. 3, pp. 1531–1537.
- [3] Chang, WK & Grady, WM 1995, 'Controlling harmonic voltage and voltage distortion in a power system with multiple active power line conditioners', IEEE Transaction on Power Delivery, vol.10, no. 3, pp. 1670–1676.
- [4] Chang, WK & Grady, WM 1997, 'Minimizing harmonic voltage distortion with multiple current-constrained active power line conditioners', IEEE Transaction on Power Delivery, vol. 12, no. 2, pp. 837–843.
- [5] Hong, YY & Chen, YT 1998, 'Three-phase active power line conditioner planning', IET Proceedings on Generation, Transmission and Distribution, vol.145, no. 3, pp. 281–287.
- [6] Hong, YY, Hsu, YL & Chen, YT 1999, 'Active power line conditioner planning using an enhanced optimal harmonic power flow method', Electric Power System Research, vol. 52, no. 2, pp. 181–188.
- [7] Chang, TT & Chang, HC 2000, 'An efficient approach for reducing harmonic voltage distortion in distribution systems with active power line conditioners', IEEE Transactions on Power Delivery, vol. 15, no. 3, pp. 990–995.
- [8] Grady, WM & Santoso, S 2001, 'Understanding power system harmonics', IEEE Power Engineering Review, vol. 1, pp. 8-11.
- [9] Keypour, R & Seifi, H 2004, 'Genetic based algorithm for active power filter allocation and sizing', Electric Power System Research, vol. 7, no. 1, pp. 41–49.
- [10] Iman Ziari & Alireza Jalilian 2010, 'A New Approach for Allocation and Sizing of Multiple Active Power-Line Conditioners', IEEE Transactions on Power Delivery, vol. 25, no. 2, pp. 1026-1035.
- [11] Iman Ziari & Alireza Jalilian 2012, 'Optimal placement and sizing of multiple APLCs using a modified discrete PSO', Electrical Power and Energy System, vol. 43, pp. 630-639.
- [12] Zhao, Y, Deng, H, Li, J & Xia, D 2001, 'Optimal planning of harmonic filter on distribution systems by chance constrained programming', Electrical Power System Research, vol. 68, no. 2, pp. 149–156.
- [13] Kennedy, J & Eberhart, R 1996, 'Particle swarm optimization', Proceedings of the International conference on neural networks, pp. 1942–1948.
- [14] Yamilledel Valle, Ganesh Kumar Venayagamoorthy, Salman Mohagheghi, Jean-Carlos Hernandez & Ronald G. Harley 2008, 'Particle Swarm Optimization: Basic Concepts, Variants and Applications in Power Systems', IEEE Transaction on Evolutionary Computation, vol. 12, no. 2, pp. 171-195.
- [15] Qin, AK, Huang, VL & Suganthan, PN 2009, 'Differential evolution algorithm with strategy adaptation for global numerical optimization', IEEE Transactions on evolutionary computation, vol.13, no. 2, pp. 398-417.
- [16] Moradi, MH & Abedini, M 2012, 'A combination of genetic algorithm and particle swarm optimization for optimal DG location and sizing in distribution systems', Electrical Power and Energy Systems, vol. 34, pp. 66–74.
- [17] Alsaadi & Gholami 2009, 'An Effective Approach for Distribution System Power Flow Solution', World Academy of Science, Engineering and Technology, vol. 25, pp. 220-224.
- [18] Wadhwa, CL 2010, Electrical Power systems, sixth edition, New age international Publishers.